

AS A227 flush mounted floor profile is applicable to all types of floors and load bearing capacity is designed for cars or pedestrians depending on the gap inquired. Pure metal structure characterizes AS A227 as a hardwearing & maintenance free profile and makes it ideal for the places with heavy pedestrian traffic. Round-headed articulated design enables the profile to meet displacements in 3 directions. Punched base frame lets the profile to be installed in an easy, quick and secured way. Profiles are delivered factory-assembled and for wide gaps soft EPDM tape is placed on the center plate to align the distance between the side frames. For surface mounted applications AS U237 model is available.

- Application Areas** : Indoor & Outdoor / Floor
- Ideal for** : Car Parks, Airports, Shopping Malls, Hospitals, Commercial & Public Buildings etc.
- Material** : Mill Finish Aluminum (Anodizing optional), Soft EPDM tape
- Aluminum Alloy** : 6063 AA-USA / EN AW 6063
- Optional Supplies** : Fire Barrier, Waterproof EPDM membrane

FLOOR

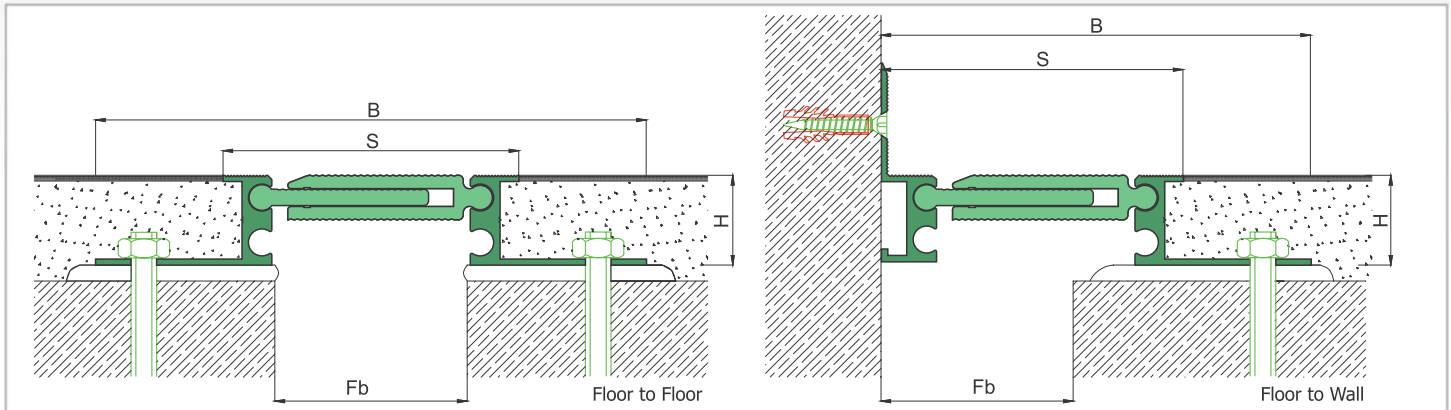
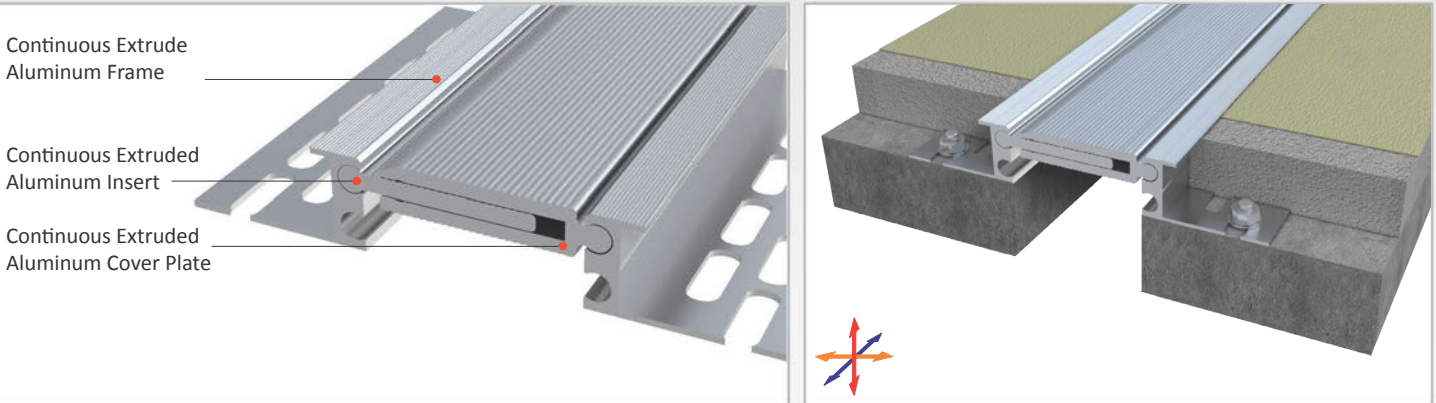

* Visuals are representative and the profile configuration may differ depending on the characteristics requested.

LOCATION	MODEL	GAP (Fb) mm	HEIGHT (H) MM	OVERALL WIDTH (B) mm	VISIBLE WIDTH (S) mm	MOVEMENT (W) mm	LOAD CAPACITY	STANDARD LENGTH (mt)
Floor to Floor	AS A227-040	40	28	150	70	± 8		3
	AS A227-060	60	28	172	92	± 5		3
	AS A227-080	80	28	190	110	± 12		3
	AS A227-100	100	28	210	130	± 17		3
	AS A227-120	120	28	230	150	± 10		3
	AS A227-140	140	28	250	170	± 20		3
	AS A227-150	150	28	260	180	± 20		3
	AS A227-180	180	28	290	210	± 20		3
	AS A227-200	200	28	310	230	± 30		3

Note: Please ask for different sizes



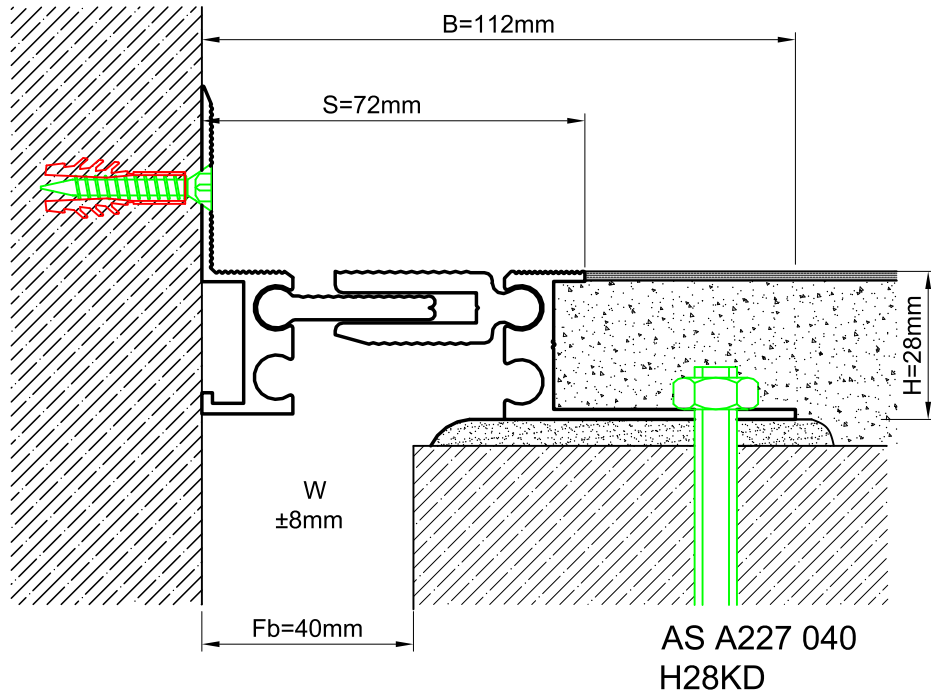
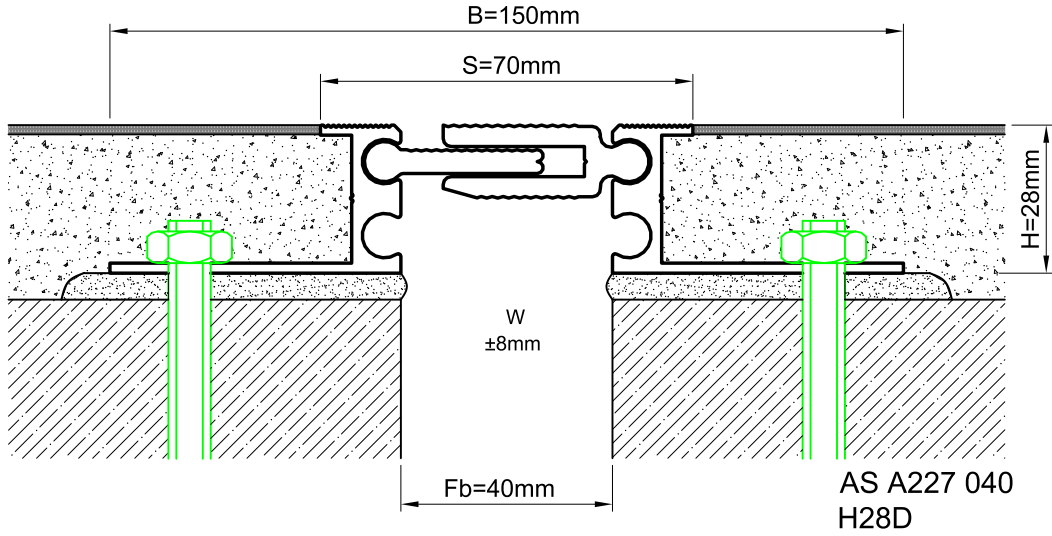

Profil No Profile Number	AS A227 040	AS A227 040K
Fb (mm)	40	40
H (mm) yaklaşık approx.	28	28
W± (mm) yaklaşık approx.	±8	±8
Renk Color	Alüminyum: Natürel Aluminum: Natural	
Malzeme Material	Alüminyum Aluminum	
Standart Uzunluk Standard Length	3	
Yükleme Kapasitesi Load-Bearing Capacity	